

METAL CATALOG

PBR-PANEL

Panel Profile

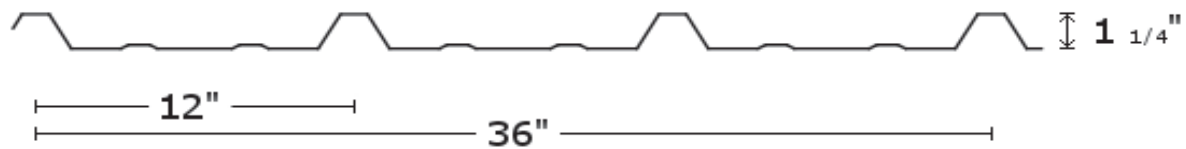

SIZE : 10' 6"

SERIES 1 RIDGE CAP*

(STANDARD)

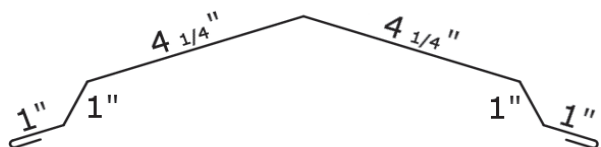

SIZE : 10' 6"

SERIES 2 RIDGE CAP*

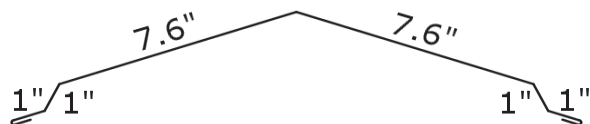

SIZE : 10' 6"

SERIES 3 RIDGE CAP*

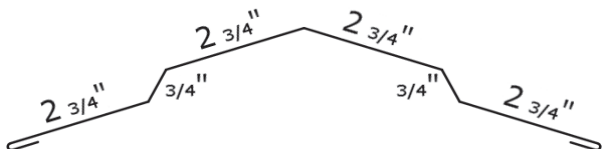

SIZE : 10' 6"

HIP RIDGE*



SIZE : 10' 2"

RAKE & CORNER

AVAILABLE IN SIZES FROM 10' 2" - 20' 6"

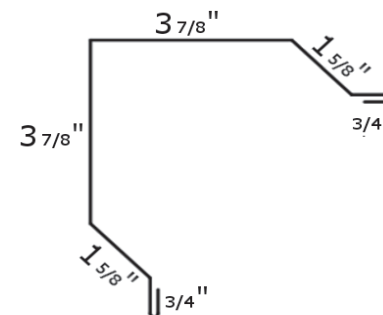

SIZE : 10' 2"

RESIDENTIAL RAKE

AVAILABLE IN SIZES FROM 10' 2" - 20' 6"

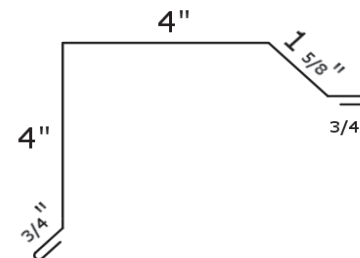

SIZE : 10' 2"

INSIDE CORNER

AVAILABLE IN SIZES FROM 10' 2" - 20' 6"

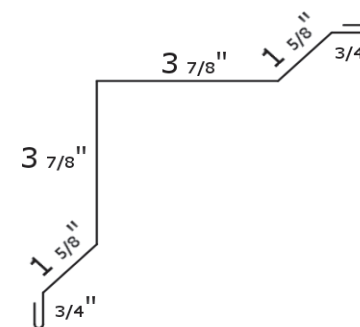

SIZE : 10' 2"

DRIP EDGE*

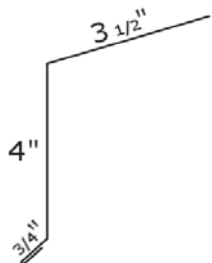

SIZE : 10' 2"

EAVE FASCIA TRIM*



SIZE : 10' 2"

3" x 3" ANGLE WITH 1 HEM*

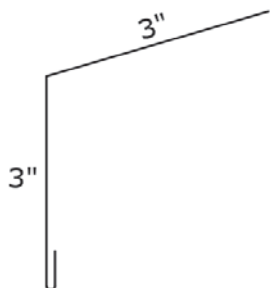

SIZE : 10' 2"

3" x 3" ANGLE WITH 2 HEM*

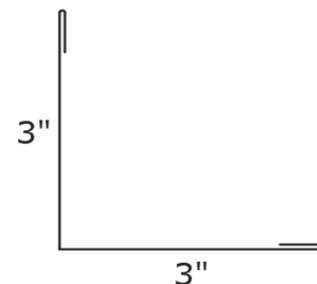

SIZE : 10' 2"

1 1/2" x 3 1/2" ANGLE

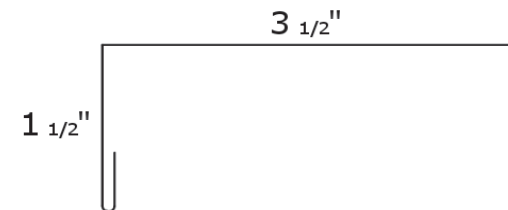

SIZE : 10' 2"

1 1/2" x 5 1/2" ANGLE

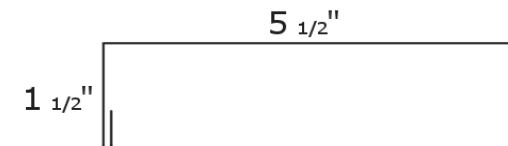

SIZE : 10' 2" ENDWALL/TRANSITION*

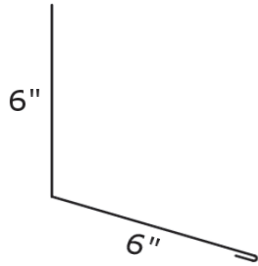

SIZE : 10' 2" SIDEWALL FLASHING

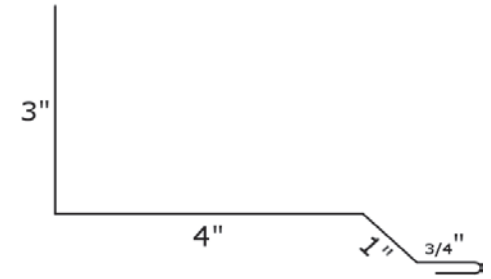

SIZE : 10' 2" VALLEY*

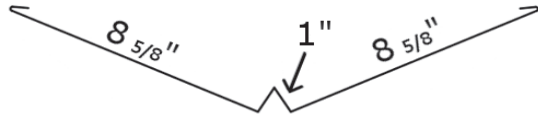

SIZE : 10' 2" ROUND DOOR TRACK COVER

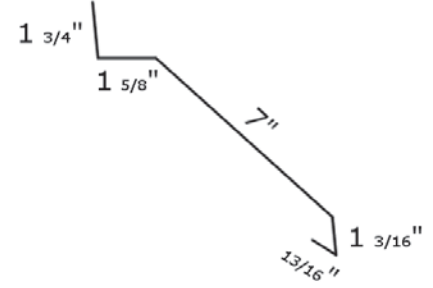

SIZE : 10' 2" UPPER GAMBREL*/LOWER GAMBREL*

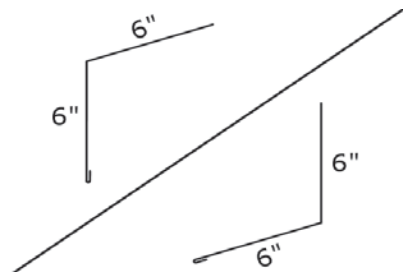

SIZE : 10' 2" OVERHEAD DOOR COVER

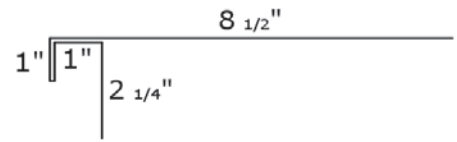

SIZE : 10' 2"

GUTTER TYPE 1*

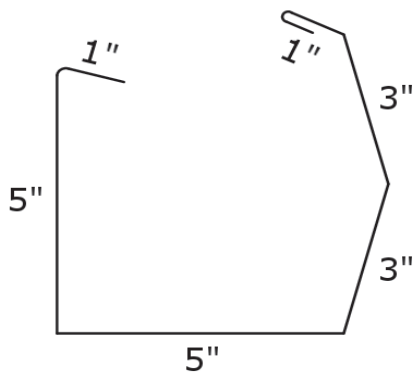

SIZE : 10' 2"

GUTTER TYPE 2*

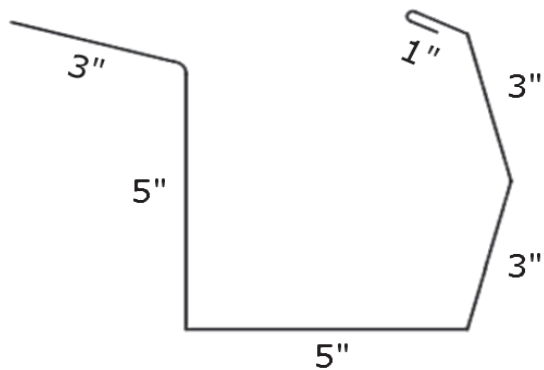

SIZE : 10' 2"

DOWNSPOUT

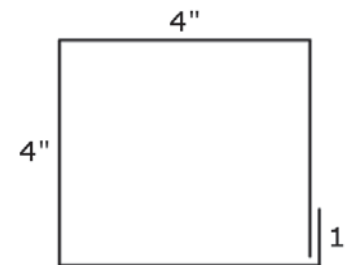

SIZE : 10' 2"

GUTTER CLIPS

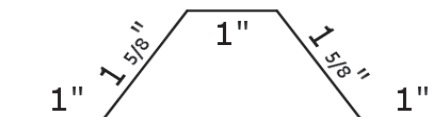

SIZE : 10' 2"

GUTTER STRAPS

